

Aantal | Omschrijving

1

ALPHA1 GO 25-60 180



Opm. De foto kan afwijken van het eigenlijke product

Artikelnr.: [93074169](#)

ALPHA1 GO is a high-efficiency circulator pump fitted with an electronically commutated motor and designed for circulating liquids in heating and air conditioning systems.

ALPHA1 GO is equipped with intelligent controls and offers three control modes: constant pressure, proportional pressure and constant curve. Each mode has three adjustable speed settings.

Replacement of older integrated and stand-alone circulator pumps, including replicating curves, is made easy by using the Grundfos GO app and operating panel.

The toolless installer plug enables a fast and easy electrical connection.

The automatic self-venting ability and dry-running protection ensure quiet operation and reliability of the pump.

The product features robust startup which reduces the risk of blockages from dirt, magnetite and limescale build-up. In the unlikely case of a blocked pump, the motor continuously attempts to start at the highest possible torque, ensuring startup in tough conditions.

The ceramic shaft and bearings experience minimal wear, resulting in a longer lifespan and a reduced likelihood of noise in the system due to increased bearing clearance from wear.

Fault finding is fast and easy by using the error codes on the pump operating panel.

Regeling:

Frequency converter: Geïntegreerd

Vloeistof:

Te verpompen medium: Water

Bereik vloeistoftemperatuur: -10 .. 110 °C

Medium temperatuur tijdens bedrijf: 20 °C

Dichtheid: 998.2 kg/m³

Technisch:

Nominaal debiet: 2.28 m³/u

Nominale opvoerhoogte: 3.06 m

Pump head orientation: 9H

TF klasse: 110

Goedkeuringen: CE,VDE

Materialen:

Pomphuis: Gietijzer

Pomp behuizing: EN 1561 EN-GJL-150

Pomphuis: ASTM A48-150B

Aantal	Omschrijving
--------	--------------

1	<p>Waaier: Composit PES+30% GF</p> <p>Installatie: Bereik van omgevingstemperatuur: 0 .. 55 °C Maximale bedrijfsdruk: 10 bar Leidingaansluiting standaard: ISO 228-1 Type aansluiting: G Maat van de aansluiting: 1 1/2 inch Druktrap voor leidingaansluiting: PN 10 Inbouwlengte: 180 mm</p> <p>Elektrische gegevens: P1 min.: 4 W P1. max: 45 W Netfrequentie: 50 / 60 Hz Nominale spanning: 1 x 220-240 V Minimum current consumption: 0.06 A Maximaal stroomverbruik: 0.45 A Dichtheidsklasse (IEC 34-5): IP44 Isolatie klasse (IEC 85): F Thermal protection: Electronic</p> <p>Overige: Energieklasse (EEI): 0.20 Netto gewicht: 2.03 kg Bruto gewicht: 2.21 kg Transportvolume: 0.004 m³ Norwegian NRF no.: 1392460 Land van herkomst: RS HS code: 84137030</p>
---	---

93074169 ALPHA1 GO 25-60 180

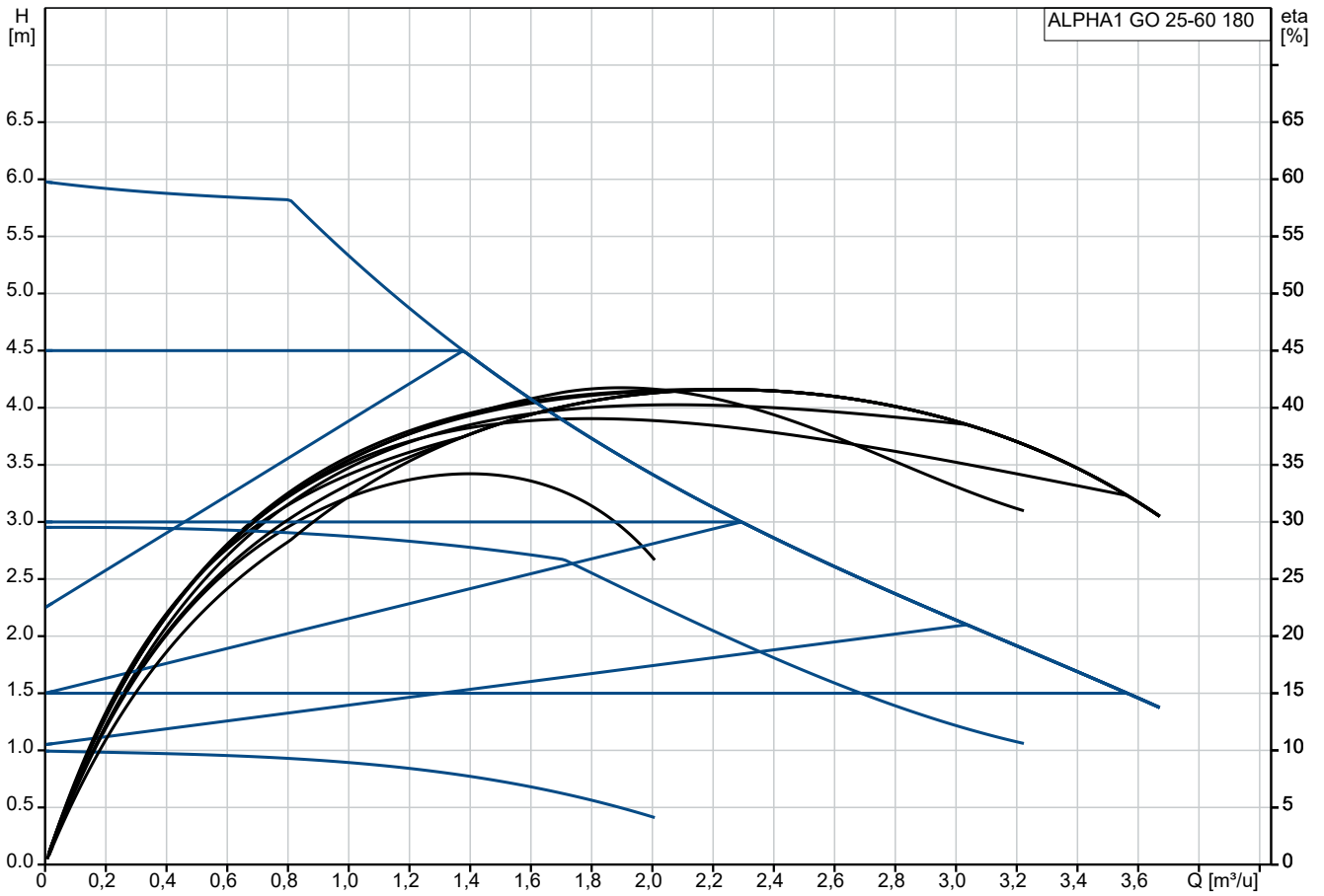

Te verpompen vloeistof = Water
Medium temperatuur tijdens bedrijf = 20 °C
Soortelijk gewicht = 998.2 kg/m³

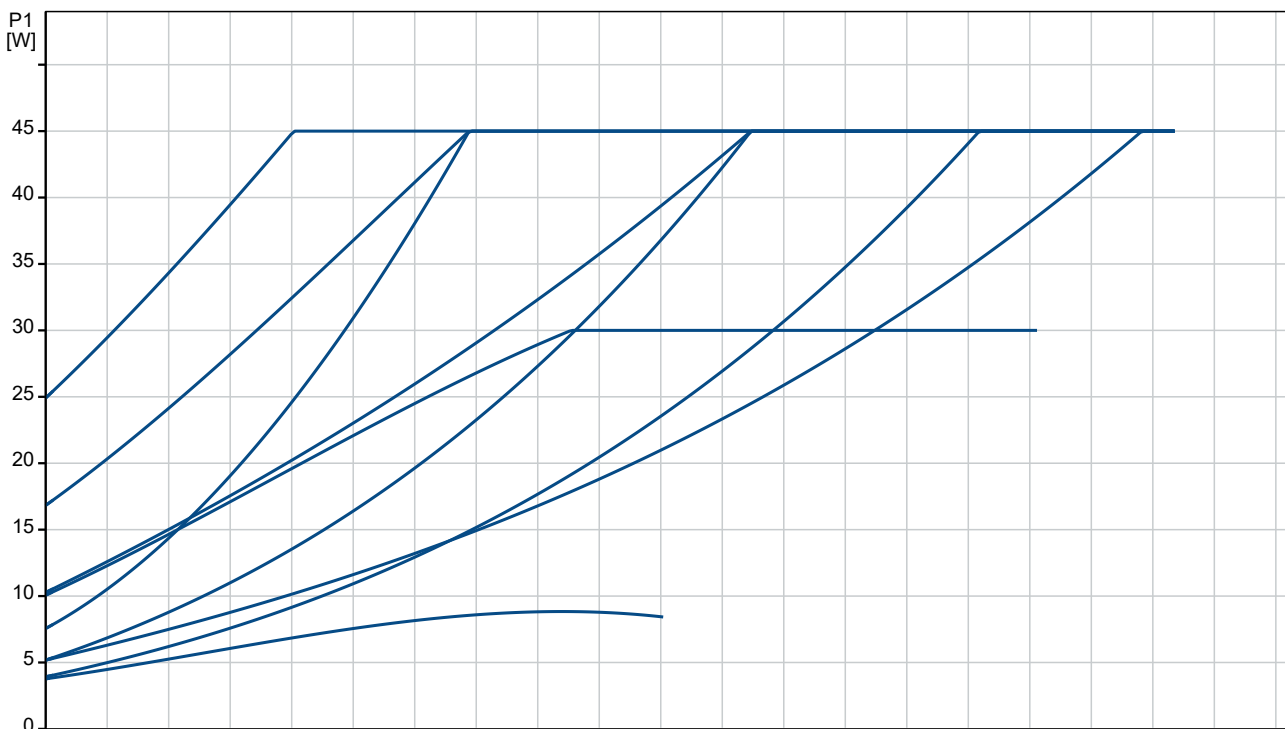

Omschrijving	Specificatie
Algemene informatie:	
Productnaam::	ALPHA1 GO 25-60 180
Productnummer::	93074169
EAN nummer::	5715467403954
Technisch:	
Nominaal debiet:	2.28 m ³ /u
Nominale opvoerhoogte:	3.06 m
Maximale opvoerhoogte:	60 dm
Pump head orientation:	9H
TF klasse:	110
Goedkeuringen:	CE, VDE
Model:	A
Materialen:	
Pomphuis:	Gietijzer
Pomp behuizing:	EN 1561 EN-GJL-150
Pomphuis:	ASTM A48-150B
Waaier:	Composiet PES+30% GF
Installatie:	
Bereik van omgevingstemperatuur:	0 .. 55 °C
Maximale bedrijfsdruk:	10 bar
Leidingaansluiting standaard:	ISO 228-1
Type aansluiting:	G
Maat van de aansluiting:	1 1/2 inch
Druktrap voor leidingaansluiting:	PN 10
Inbouw lengte:	180 mm
Vloeistof:	
Te verpompen medium:	Water
Bereik vloeistoftemperatuur:	-10 .. 110 °C
Medium temperatuur tijdens bedrijf:	20 °C
Dichtheid:	998.2 kg/m ³
Elektrische gegevens:	
P1 min.:	4 W
P1. max:	45 W
Netfrequentie:	50 / 60 Hz
Nominale spanning:	1 x 220-240 V
Minimum current consumption:	0.06 A
Maximaal stroomverbruik:	0.45 A
Dichtheidsklasse (IEC 34-5):	IP44
Isolatie klasse (IEC 85):	F
Thermal protection:	Electronic
Regeling:	
Frequentie omvormer:	Geïntegreerd
Overige:	
Energieklasse (EEI):	0.20
Netto gewicht:	2.03 kg
Bruto gewicht:	2.21 kg
Transportvolume:	0.004 m ³
Norwegian NRF no.:	1392460
Land van herkomst:	RS
HS code:	84137030

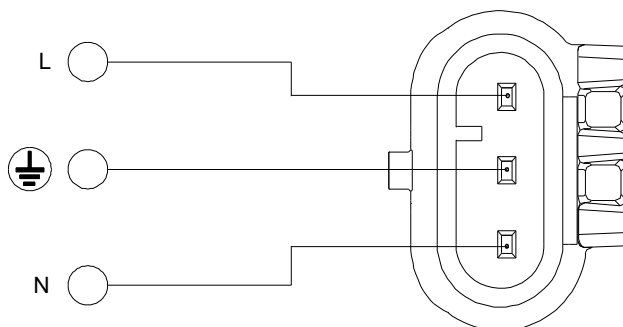
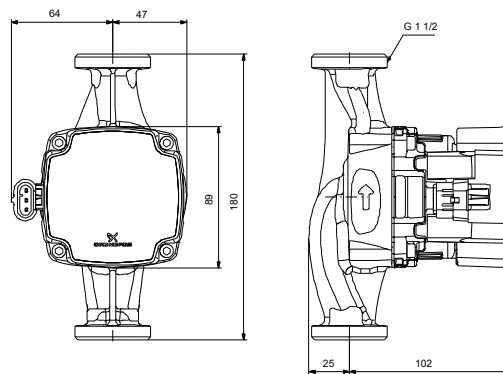
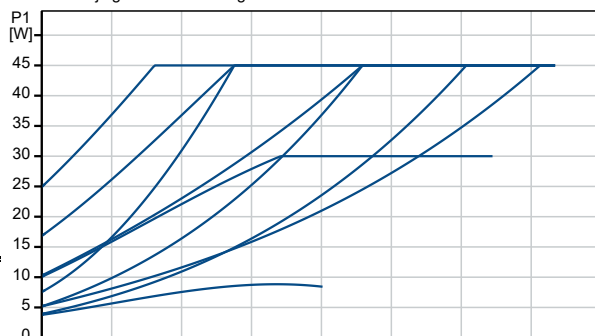
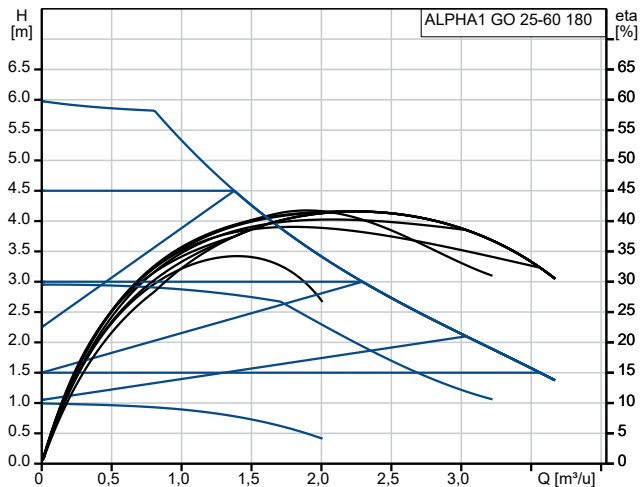

93074169 ALPHA1 GO 25-60 180

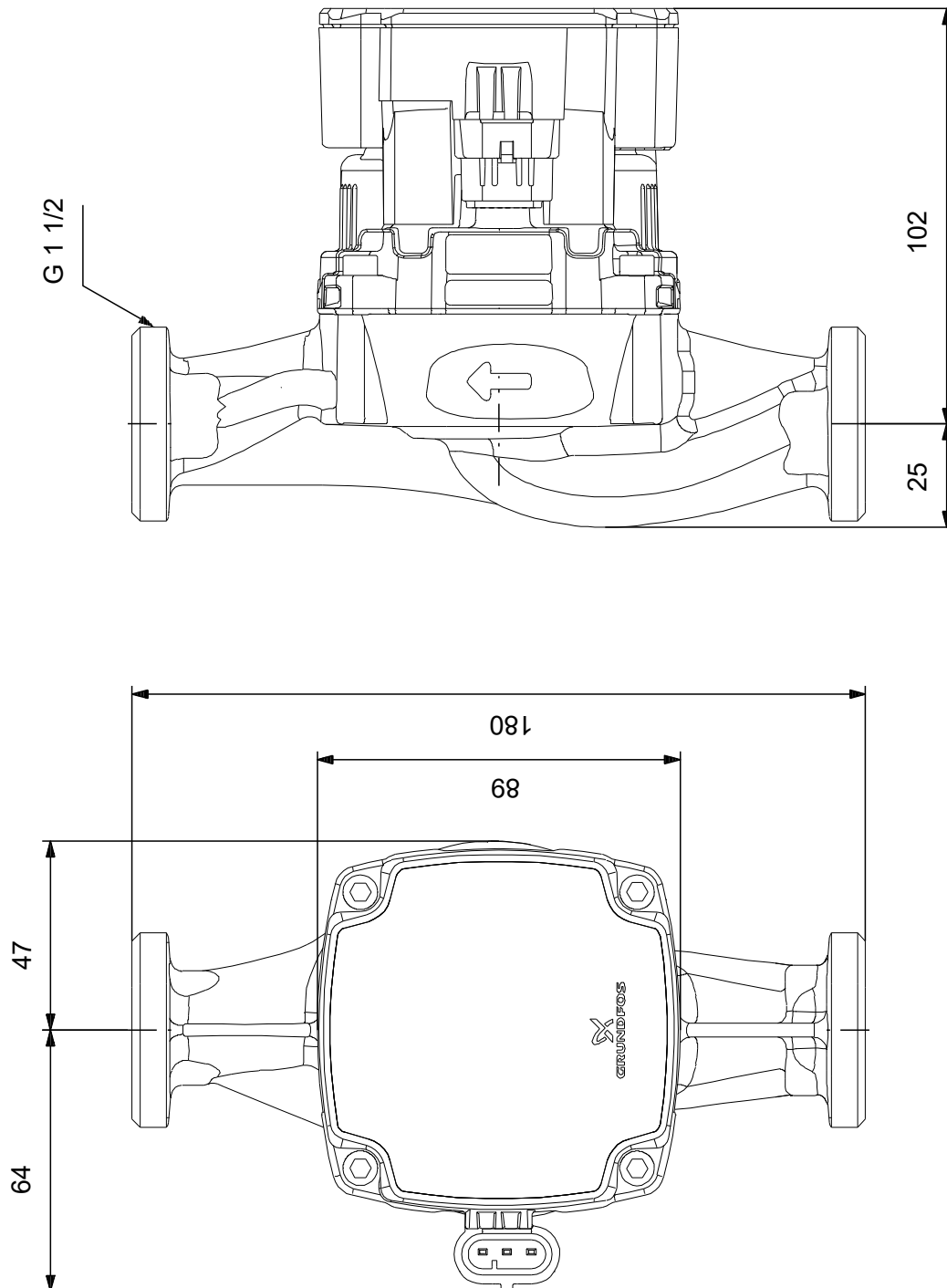

Opm! Alle unit's zijn in [mm] tenzij anders aangegeven.
Disclaimer: Deze eenvoudige maatschets toont u niet alle details.

93074169 ALPHA1 GO 25-60 180

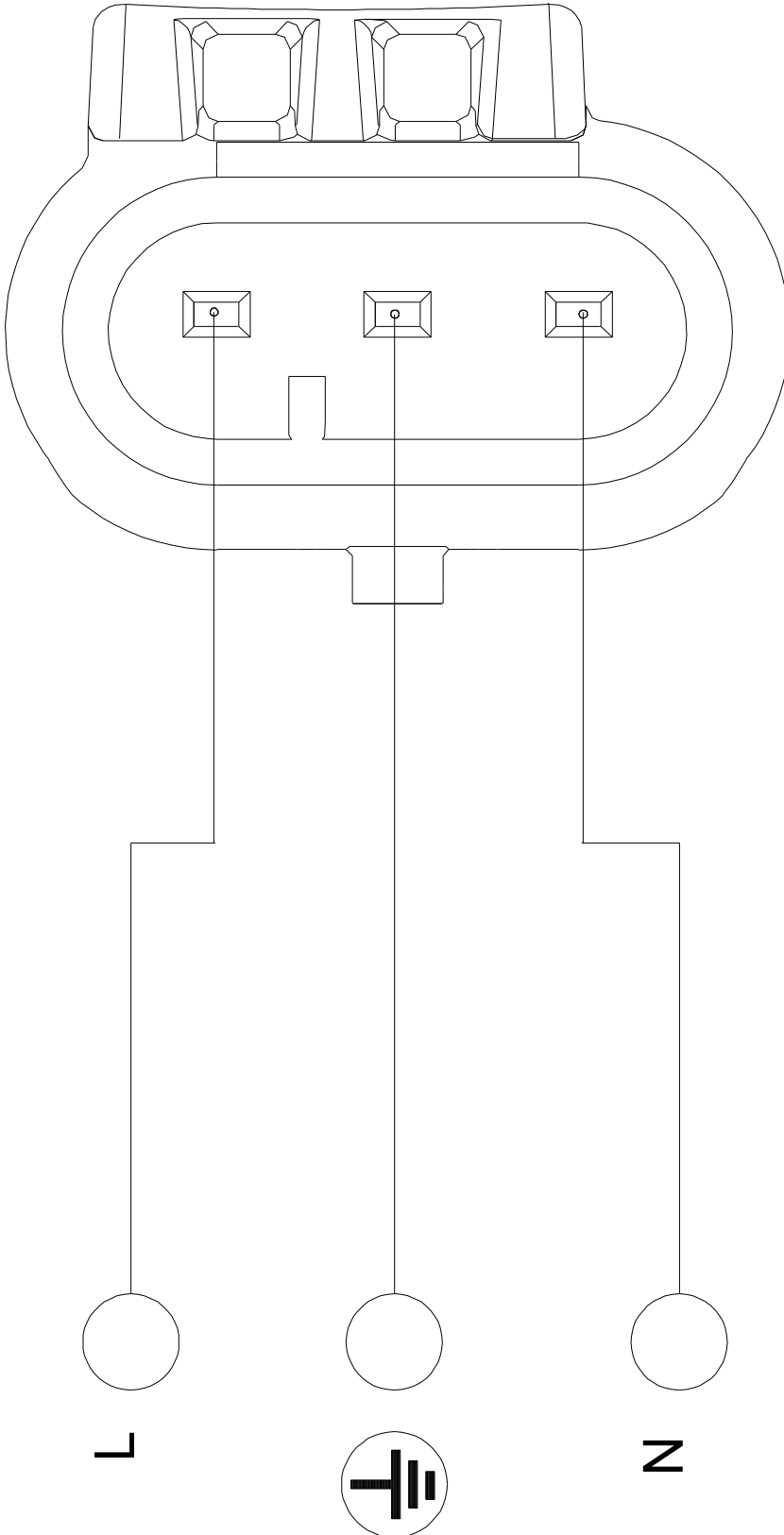

Opm.: Alle eenheden in (mm) tenzij anders vermeld

